

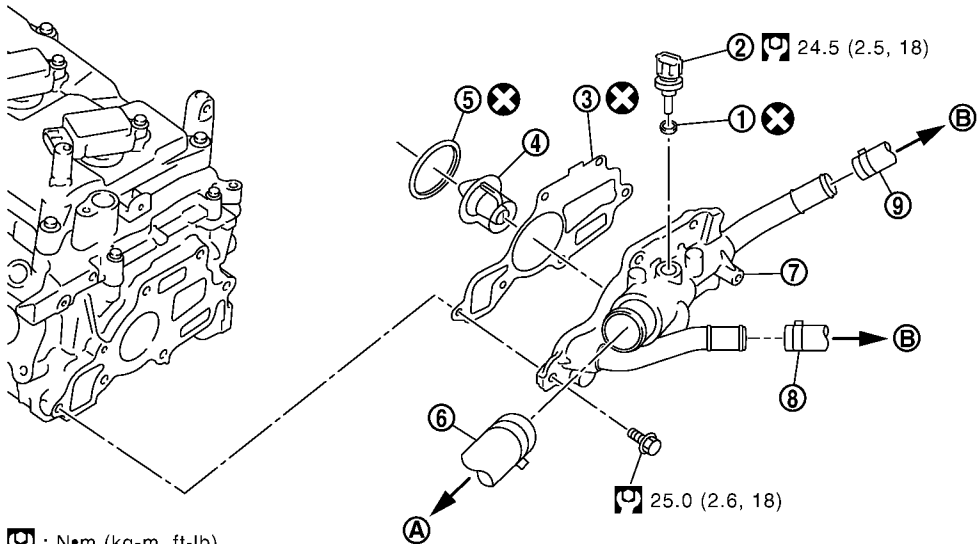

SEC. 210•211



 : N•m (kg-m, ft-lb)