

SEC. 172

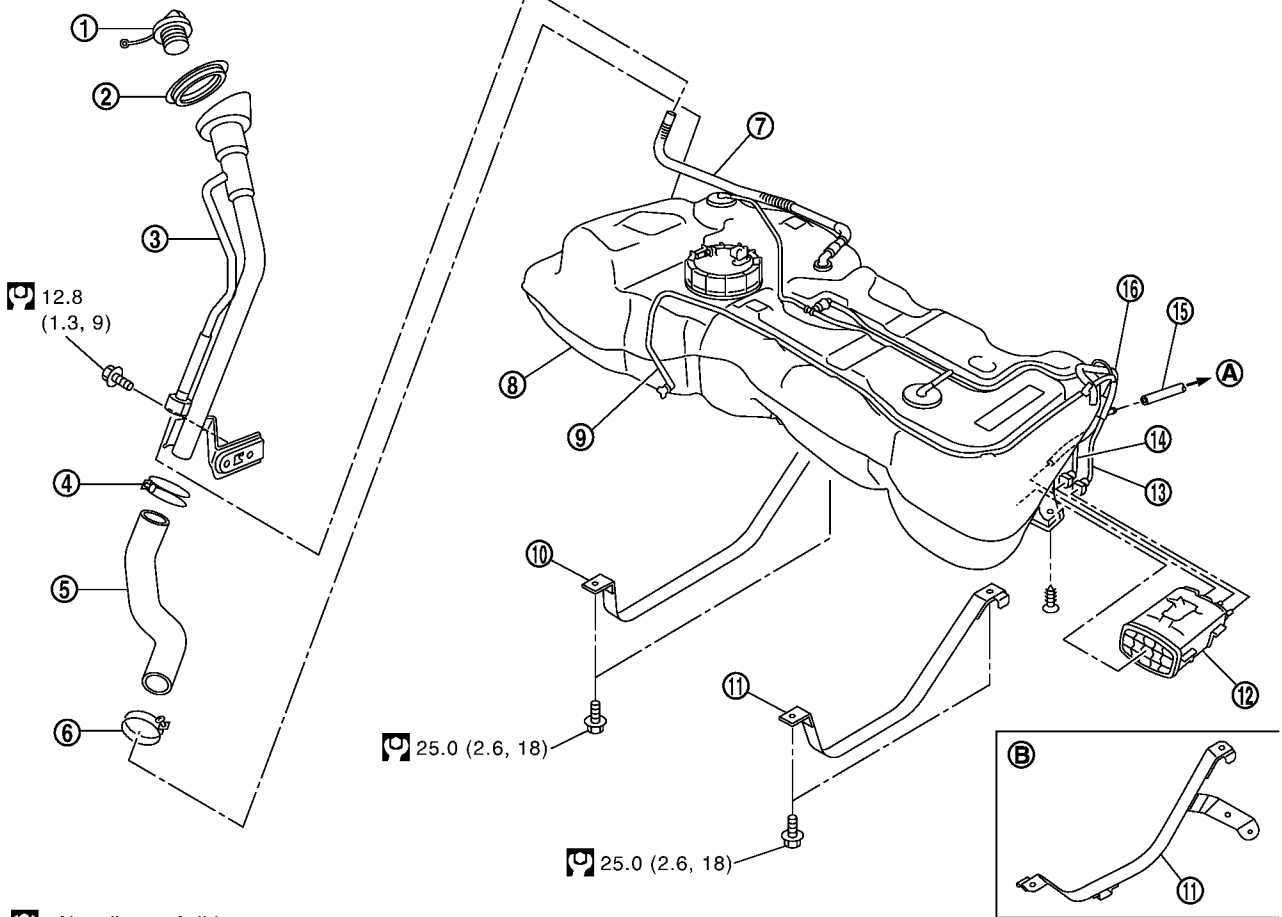

: N•m (kg-m, ft-lb)